

CurtisMathes

TV/VCR Combination Unit

Owner's Manual

CMC13410

CMC19410

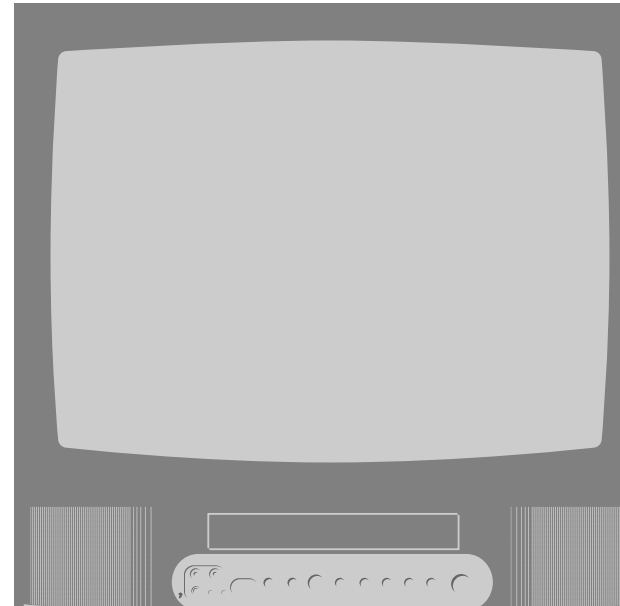

IMPORTANT SAFETY INSTRUCTIONS



Warning! Important Safety Instructions

CAUTION

RISK OF ELECTRIC SHOCK
DO NOT OPEN

CAUTION: TO REDUCE THE RISK OF ELECTRIC SHOCK, DO NOT REMOVE COVER (OR BACK). NO USER SERVICEABLE PARTS INSIDE. REFER SERVICING TO QUALIFIED SERVICE PERSONNEL.



This symbol indicates high voltage is present inside. It is dangerous to make any kind of contact with any inside part of this product.



This symbol alerts you that important literature concerning operation and maintenance has been included with this product.

Note to CATV system installer: This reminder is provided to call CATV system installer's attention to Article 820-40 of the National Electrical Code (Section 54 of Canadian Electrical Code, Part I), that provides guidelines for proper grounding and, in particular, specifies that the cable ground shall be connected to the grounding system of the building as close to the point of cable entry as practical.

Caution: FCC regulations state that any unauthorized changes or modifications to this equipment may void the user's authority to operate it.

Caution: To prevent electric shock, match the wide blade of plug to the wide slot, and fully insert the plug.

Important: One Federal Court has held that unauthorized recording of copyrighted TV programs is an infringement of U.S. copyright laws.

To prevent damage which may result in fire or electric shock hazard, do not expose this appliance to rain or moisture.

Save These Instructions

Important Safety Information



Always be careful when using your TV/VCR. To reduce the risk of fire, electrical shock, and other injuries, keep these safety precautions in mind when installing, using, and maintaining your machine.

- Read all safety and operating instructions before operating the TV/VCR.
- Retain the safety and operating instructions for future reference.
- Heed all warnings on the TV/VCR and in the operating instructions.
- Follow all operating and use instructions.
- Unplug the TV/VCR from the wall outlet before cleaning. Use a damp cloth; do not use liquid or aerosol cleaners.
- Never add any attachments and/or equipment without approval of the manufacturer. Such additions may result in the risk of fire, electric shock, or other personal injury.
- Do not use the TV/VCR where contact with or immersion in water is a possibility, such as near bath tubs, sinks, washing machines, swimming pools, etc.
- Provide ventilation for the TV/VCR. The unit is designed with slots in the cabinet for ventilation to protect it from overheating. Do not block these openings, and do not place the TV/VCR on a bed, sofa, rug, or other similar surface. Do not place it near a radiator or heat register. If you place the TV/VCR on a rack or bookcase, ensure that there is adequate ventilation and that you've followed the manufacturer's instructions for mounting.

IMPORTANT SAFETY INSTRUCTIONS

Save These Instructions

Important Safety Information, *continued*

- Do not place the TV/VCR on an unstable cart, stand, tripod, bracket, or table. The TV/VCR may fall, causing serious injury to a child or adult, and serious damage to the unit. Use only with a cart, stand, tripod, bracket, or table recommended by the manufacturer or sold with the TV/VCR. Follow the manufacturer's instructions when mounting the unit, and use a mounting accessory recommended by the manufacturer. Move the TV/VCR and its cart with care. Quick stops, excessive force, and uneven surfaces may cause the unit and cart to overturn.
- Operate your TV/VCR only from the type of power source indicated on the marking label. If you are not sure of the type of power supplied to your home, consult your appliance dealer or local power company.
- Use only a grounded or polarized outlet. For your safety, this TV/VCR is equipped with a polarized alternating current line plug having one blade wider than the other. This plug will fit into the power outlet only one way. If you are unable to insert the plug fully into the outlet, try reversing the plug. If the plug still doesn't fit, contact your electrician to replace your outlet.
- Protect the power cord. Power supply cords should be routed so that they are unlikely to be walked on or pinched by items placed on or against them. Pay particular attention to cords at plugs, convenience receptacles, and the point where they exit from the unit.
- Unplug the TV/VCR from the wall outlet and disconnect the antenna or cable system during a lightning storm or when left unattended and unused for long periods of time. This will prevent damage to the unit due to lightning and power-line surges.



- Avoid overhead power lines. An outside antenna system should not be placed in the vicinity of overhead power lines or other electric light or power circuits or where it can fall into such power lines or circuits. When installing an outside antenna system, be extremely careful to keep from touching the power lines or circuits. Contact with such lines can be fatal.
- Do not overload the wall outlet or extension cords. Overloading can result in fire or electric shock.
- Do not insert foreign objects through openings in the unit, as they may touch dangerous voltage points or damage parts. Never spill liquid of any kind on the TV/VCR.

IMPORTANT SAFETY INSTRUCTIONS

Save These Instructions

Important Safety Information, *continued*

- Ground outdoor antennas. If an outside antenna or cable system is connected to the TV/VCR, be sure the antenna or cable system is grounded so as to provide some protection against voltage surges and built-up static charges. Section 810 of the National Electrical Code, ANSI/NFPA No. 70-1984, provides information with respect to proper grounding of the mast and supporting structure, grounding of the lead-in wire to an antenna discharge unit, size of grounding conductors, location of antenna-discharge unit, connection to grounding electrodes, and requirements for the grounding electrode.
- Do not attempt to service the TV/VCR yourself. Refer all servicing to qualified service personnel. Unplug the unit from the wall outlet and refer servicing to qualified service personnel under the following conditions:
 - when the power-supply cord or plug is damaged
 - if liquid has been spilled on or objects have fallen into the unit
 - if the TV/VCR has been exposed to rain or water
 - if the TV/VCR does not operate normally by following the operating instructions
 - if the TV/VCR has been dropped or the cabinet has been damaged
 - when the TV/VCR exhibits a distinct change in performance

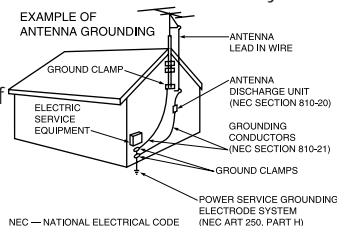

- If you make adjustments yourself, adjust only those controls that are covered by the operating instructions. Adjusting other controls may result in damage and will often require extensive work by a qualified technician to restore the TV/VCR to normal.
- When replacement parts are required, be sure the service technician uses replacement parts specified by the manufacturer or those that have the same characteristics as the original part. Unauthorized substitutions may result in additional damage to the unit.
- Upon completion of any service or repairs to this TV/VCR, ask the service technician to perform safety checks to determine that the TV/VCR is in a safe operating condition.

This device complies with part 15 of the FCC Rules. Operation is subject to the following two conditions:
(1) This device may not cause harmful interference, and
(2) This device must accept any interference that may cause undesired operation.

This television receiver provides display of television closed captioning in accordance with §15.119 of the FCC rules.

CONTENTS

Chapter 1: Learning About Your New TV/VCR	7	Choosing Picture Settings.....	20
List of Features.....	7	Customizing Picture Settings	20
Checking Parts.....	7	Resetting Standard Picture Settings	21
Understanding the Controls	8	Setting the Sleep Timer.....	22
Front Panel Controls & Jacks	8	Using the On/Off Timer	22
Rear Panel.....	9	Chapter 4: VCR Operation	23
Remote Control.....	10	Inserting and Ejecting a Video Tape	23
Chapter 2: Installation	12	Playing a Video Tape.....	23
Connecting VHF and UHF Antennas	12	Playing a Tape.....	23
Antennas With 300-ohm Flat Twin Leads.....	12	Pausing	23
Antennas With 75-ohm Round Leads.....	12	Using Picture Search.....	24
Separate VHF and UHF Antennas.....	12	Using Tracking	24
Connecting Cable TV Systems to the TV/VCR.....	13	Using the Time Counter.....	24
Cable Without a Converter Box	13	Using Memory Stop	24
Cable With a Converter Box	13	Using P.PLUS.....	25
Installing Batteries in the Remote Control	15	Recording TV Programs as You Watch	25
Chapter 3: TV Operation	16	Recording	25
Viewing the On-screen Display	16	Editing While Recording	26
Viewing the Main Menu	16	Using Advanced Recording Features	26
Selecting the On-screen Language.....	16	One-touch Recording.....	26
Selecting the Signal Source.....	17	Timer Recording	26
Programming the Channels	17	Using Program Review	29
Setting the Clock	18		

CONTENTS

Chapter 5: Special Features	30	Chapter 6: Troubleshooting	38
Using True Repeat	30	Identifying TV Problems	38
Using Block Repeat	30	Identifying VCR Problems	38
Viewing Closed Captions.	31		
Using the V-Chip	32	Appendix	39
Setting Up Your Personal ID Number(PIN)	32	Caring for Your TV/VCR	39
How to Enable/Disable the V-Chip	32	Placement	39
How to Set Up Restrictions		Liquids	39
Using the "TV guidelines"	33	Cabinet.	39
How to Set Up Restrictions Using the MPAA		Video Heads	39
Ratings; G, PG, PG-13, R, NC-17, X	34	Temperature	39
How to Reset the TV after the V-Chip Blocks		About Video Tapes.	39
a channel ("Emergency Escape")	35	Caring for Video Tapes.	39
Using Special Playback Features.	36	Recording Speeds	39
Frame Advance.	36	The Record Safety Tab.	39
Skip Search.	36	Specifications.	40
Slow Motion	36		
Jet Search.	36		
Copying, or Dubbing, a Video	37		
Making the Connections	37		
Dubbing	37		

List of Features

Your TV/VCR was designed and engineered using the latest technology. This TV/VCR is a full-featured, high-performance unit that not only meets, but exceeds, industry standards. Along with the standard features you expect, TV/VCR has included the following special features:

- Easy-to-operate infrared remote control
- Easy-to-use on-screen menu system you can use from the front panel or the remote control
- Closed captioning
- On-screen programmed recording of up to six events in one year
- Digital auto-tracking
- Repeat play
- Infrared wireless remote control system
- Quick start, full loading system
- High speed rewinding
- High quality video circuitry
- 181-channel capability (frequency synthesized tuner)
- Auto channel programming
- One-touch recording (up to four hours)
- Eight hour recording on a single T-160 video cassette
- Auto clock setting
- Rental picture plus
- Tri-lingual on-screen displays (English, Spanish, and French)
- V-chip feature
- Jet-search

Checking Parts

Once you have unpacked your TV/VCR, check to make sure that you have all the parts shown here. If any piece is missing or broken, call your dealer.

(The TV illustration shown does not necessarily match the design of your TV set.)

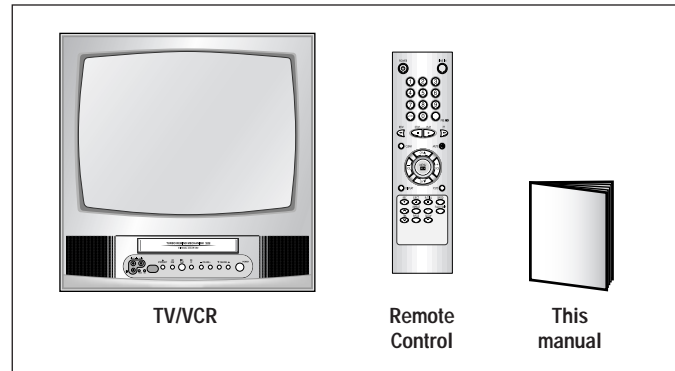

LEARNING ABOUT YOUR NEW TV/VCR

Understanding the Controls

Front Panel Controls & Jacks

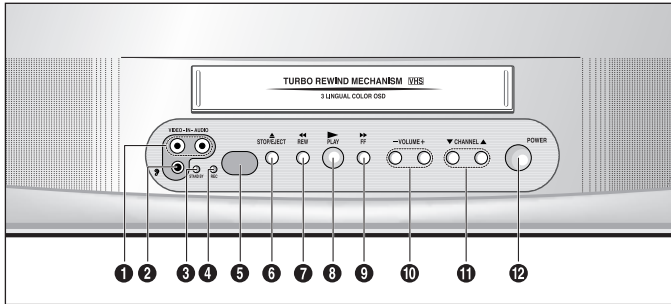

The buttons on the front panel control basic features. For more advanced features, you will use the remote control.

- 1 VIDEO and AUDIO IN jacks**
Connect components, such as a camcorder, to these jacks.

- 2 EARPHONE jack**
Connect a set of earphones (with a mini connector) to this jack.
- 3 STAND BY indicator**
Lit when TV/VCR power is Off.
- 4 REC indicator**
Lit when the TV/VCR is recording or when program times are stored.

- 5 REMOTE sensor**
Receives signals from the remote control.
- 6 STOP/EJECT button**
Press to stop a video tape during play, record, rewind, or fast forward. Press to eject a video tape if the tape is stopped.

- 7 REW button**
Press to rewind a video tape.
- 8 PLAY button**
Press to play a video tape.

- 9 FF button**
Press to fast forward a video tape.
- 10 -VOL and VOL+ buttons (VOLUME)**
Press to change the volume or to change features on the menu.

- 11 CH▼ and CH▲ buttons (CHANNEL)**
Press to change channels or to select features on the menu.
- 12 POWER button**
Press to turn the TV/VCR on or off.

LEARNING ABOUT YOUR NEW TV/VCR

Understanding the Controls, *continued*

Rear Panel

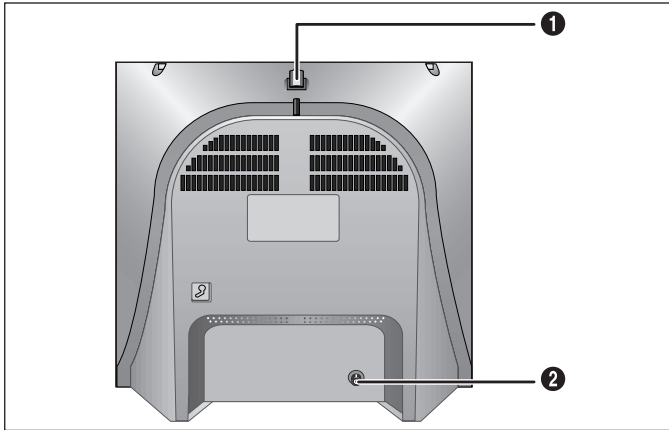

- 1 VHF antenna mount**
VHF rod antenna mount.
See page 6.
- 2 Antenna terminal**
Use this terminal (VHF/UHF
IN FROM ANT) to connect
the TV/VCR to a 75-ohm
outdoor antenna or cable
system. See page 6.

LEARNING ABOUT YOUR NEW TV/VCR

Understanding the Controls, *continued*

Remote Control

Use the remote control within 33 feet (10 meters) of the TV/VCR and point it directly at the TV/VCR.

- 1 POWER**
Press to turn the TV/VCR on and off.
- 2 NUMBER BUTTONS**
Press to select specific channels.
- 3 +100**
Press to select channels over 100.
- 4 REW** (rewind)
Press to rewind a tape.
- 5 STOP**
Press to stop a tape.
- 6 PLAY**
Press to play a tape.
- 7 FF** (fast forward)
Press to fast forward a tape.
- 8 CLEAR**
Press to correct programming errors, clear programs, or reset the tape counter.
- 9 -VOL and VOL+** (volume)
Press - VOL to decrease or VOL+ to increase the volume.
- 10 CH▲ and CH▼** (channel)
Press CH▲ or CH▼ to change channels. Also used with the menu system.
- 11 MENU**
Press to display the on-screen menu.
- 12 DISPLAY**
Press to show on-screen displays.
- 13 LINE IN**
Press to select the component connected to the Audio/Video jacks.
- 14 PRE-CH** (previous channel)
Press to return to the last channel viewed.

- 15 MUTE**
Press to silence the volume.
- 16 P.STD** (picture-standard)
Press to select memorized or standard picture settings.

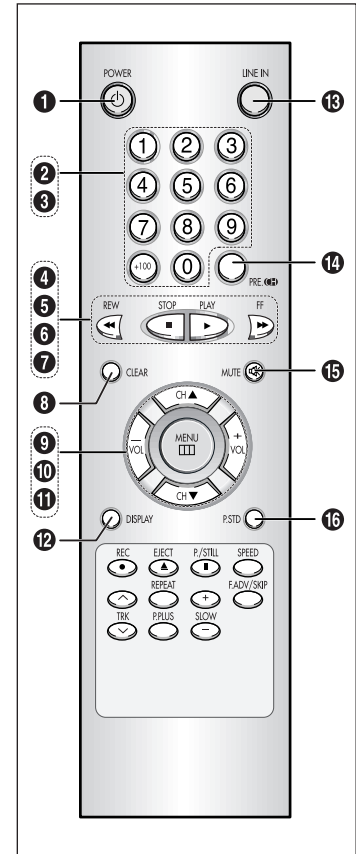

LEARNING ABOUT YOUR NEW TV/VCR

Understanding the Controls, *continued*

Remote Control

Use the remote control within 33 feet (10 meters) of the TV/VCR and point it directly at the TV/VCR.

17 EJECT

Press to eject a tape.

18 REC (record)

Press to begin recording.

19 TRK+, - (tracking)

Press to adjust tape tracking.

20 P.PLUS

Press to compensate for a poor rental tape.

21 P. (pause)/STILL

Press to freeze a video frame.

22 SPEED

Press to select the tape recording speed.

23 F.ADV (frame advance)/SKIP

Press to advance a tape frame-by-frame or to use skip search.

24 SLOW+, -

Press to watch a tape in slow motion.

25 REPEAT

Press to play a tape or a section of tape repeatedly.

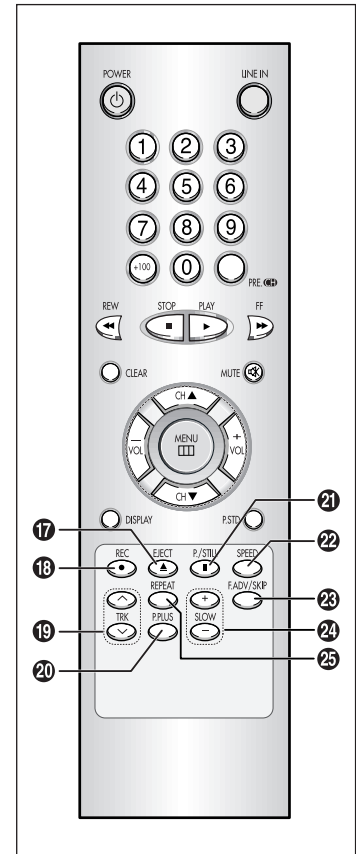

Connecting VHF and UHF Antennas

If you do not have cable TV, you must connect an antenna to your TV/VCR. First you need to identify your antenna's lead type:

- If you are using the antenna that has 300-ohm twin flat leads, (see the illustration below) see "Antennas With 300-ohm Flat Twin Leads," on this page.

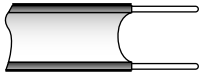

- If your antenna has a 75-ohm round lead (see the illustration below), see "Antennas With 75-ohm Round Leads," on this page.



- If you have two antennas, see "Separate VHF and UHF Antennas," on this page.

Antennas With 300-ohm Flat Twin Leads

If you use a different 300-ohm antenna with twin flat leads, follow the directions below, but skip step 1.

- 1 Push the stem of the rod antenna into the antenna mount.

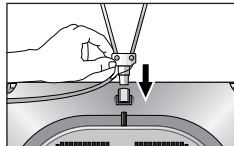

- 2 Place the wires from the twin leads under the screws on the 300-75 ohm adapter (not supplied). Use a screwdriver to tighten the screws.

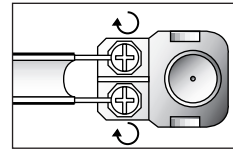

- 3 Plug the adapter into the terminal on the rear panel of the TV/VCR.

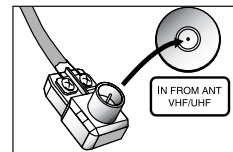

Extend the antenna and adjust it for the clearest picture. To reduce the risk of damage, only adjust the antenna by moving the black plastic base.

Antennas With 75-ohm Round Leads

- 1 Plug the lead into the terminal on the rear panel of the TV/VCR.

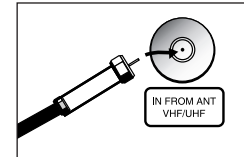

Separate VHF and UHF Antennas

If you have two separate antennas for your TV/VCR (one VHF and one UHF), you must combine the two antenna signals before connecting them to the TV/VCR. This procedure requires a combiner attachment that you can purchase at an electronics store.

INSTALLATION

Connecting VHF and UHF Antennas, *continued*

If you use a different 300-ohm antenna with twin flat leads, follow the directions below, but skip step 1.

- 1 Push the stem of the rod antenna into the antenna mount.

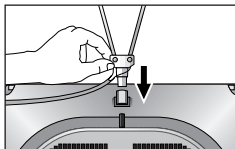

- 2 Connect both antenna leads to a combiner.

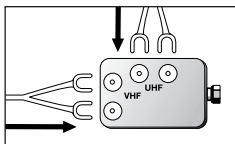

- 3 Plug the combiner into the terminal on the rear panel of the TV/VCR.

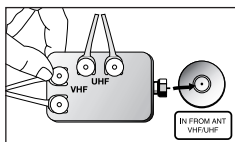

Connecting Cable TV Systems to the TV/VCR

Choose one of the sections below for connecting a cable system.

- ✓ This TV/VCR is cable-ready; you don't need a converter for basic cable channels.

Cable Without a Converter Box

To connect cable without a converter box:

- 1 Plug the incoming cable into the terminal on the rear panel of the TV/VCR.

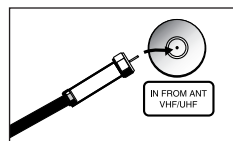

Cable With a Converter Box

If your cable company scrambles some channels and requires you to use a converter box for only those channels, use these instructions.

You will need the following pieces of equipment, which you can purchase from an electronics store:

- A two-way splitter
 - An RF (A/B) switch
 - Four lengths of coaxial cable
- 1 Plug the incoming cable into the 2-way splitter.

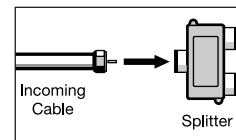

INSTALLATION

Connecting Cable TV Systems to the TV/VCR, *continued*

- 2 Connect one of the coaxial cables between the splitter and the input on the converter box.

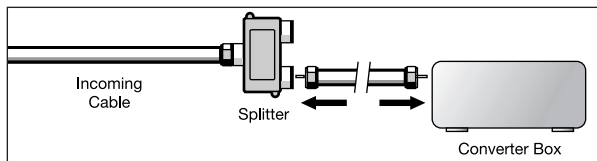

- 3 Connect a second coaxial cable between the output of the converter box and the "B" input on the RF (A/B) switch.

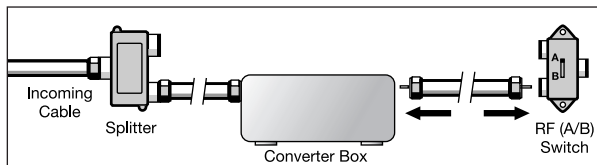

- 4 Connect a third coaxial cable between the splitter and the "A" input on the RF (A/B) switch.

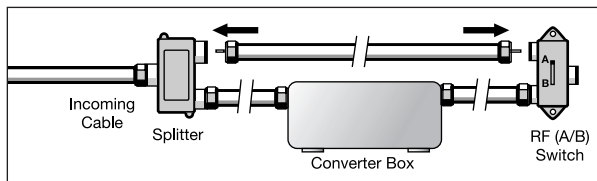

- 5 Connect the fourth coaxial cable between the output on the RF (A/B) switch and the terminal on the TV/VCR's back panel.

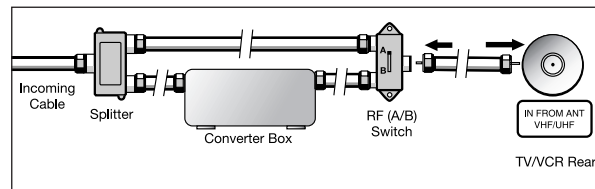

Choose the "A" position on the A/B switch to select all non-scrambled channels by remote control. Choose the "B" position on the A/B switch to select scrambled channels via the converter box. When using the "B" position, tune your TV/VCR to the output channel of the converter box (usually channel 3 or 4).

INSTALLATION

Installing Batteries in the Remote Control

- 1 Open the battery compartment by pressing down on the back cover's tab, then lifting up.

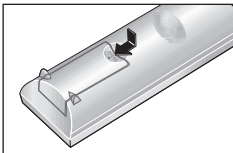

- 2 Install two AAA size batteries. Make sure to match the + and – ends of the batteries with the diagram inside the compartment.

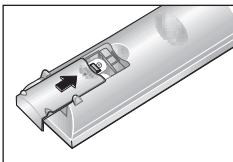

- 3 Replace the cover.

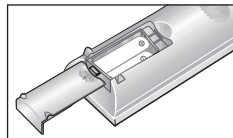

- ✓ If you won't be using the remote control for a long time, remove the batteries and store them in a cool, dry place.
- ✓ Batteries last for about one year.

Viewing the On-screen Display

The on-screen display automatically appears on the screen when you turn the TV/VCR on or change its status (from stop to play, from play to stop, etc.). You can also activate the on-screen displays manually by using the remote control.

- 1 With the power on, press DISPLAY.

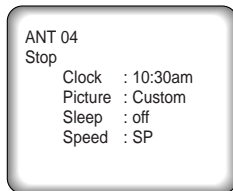

- ✓ This display disappears from the screen within ten seconds.

- 2 Press DISPLAY again (while the display items are still on the TV/VCR screen) to display the time counter.



Press DISPLAY once more to remove all displays from the screen and return to normal viewing.

Viewing the Main Menu

- 1 With the power on, press MENU.

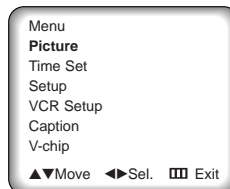

The main menu appears on the screen. Press MENU again to remove the main menu from the screen.

The menu will disappear from the screen in less than thirty seconds if you don't press any buttons on the remote.

Selecting the On-screen Language

On-screen text can appear in English, Spanish, or French.

- 1 Press MENU to display the menu.
- 2 Press CH▼ until "Setup" is selected. Press VOL+.

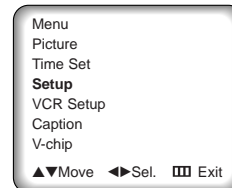

- 3 Press CH▼ until "Language" is selected. Press VOL- or VOL+ to select the on-screen language you want.



TV OPERATION

Selecting the Signal Source

The first step in programming your TV/VCR is to select the signal source of your antenna or cable TV system.

- 1 Press MENU to display the menu.
- 2 Press CH▼ until "Setup" is highlighted. Press VOL+.

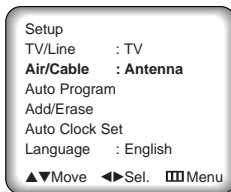

- 3 Press VOL- or VOL+ to select "Antenna," "Cable STD," "Cable HRC," or "Cable IRC."

- ✓ If your TV/VCR is connected to an antenna, select "Antenna." If you have cable TV, select "Cable STD," "Cable HRC," or "CABLE IRC," depending on the type of cable system you have.

Programming the Channels

Storing Channels in Memory

Your TV/VCR can automatically memorize all the channels you receive. Once they are in memory, you can use CH▲ and CH▼ to select channels without using the number buttons.

- ✓ Before you can store channels in memory, you must have already selected the signal source. See "Selecting the Signal Source" on this page.

- 1 Press MENU to display the menu.
- 2 Press CH▼ until "Setup" is highlighted. Press VOL+.

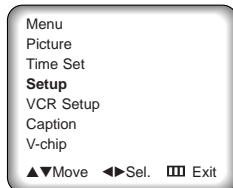

- 3 Press CH▼ until "Auto Program" is highlighted.

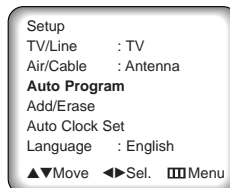

- 4 Press VOL- or VOL+ button to begin automatic programming.

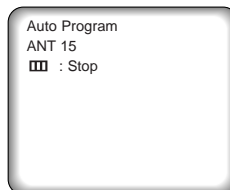

The TV/VCR automatically cycles through all the channel numbers and places the available channels in memory. This takes two to three minutes.

- ✓ Press MENU at any time to interrupt the programming process and return to normal viewing.

- 5 When the programming process is complete, press CH▲ or CH▼ to scan the channels stored in the TV/VCR's memory.

- ✓ Occasionally the TV/VCR will miss an active channel if the signal is weak or if the channel is off the air when you start programming. Likewise, an unavailable channel may be included in memory if there are stray signals on that channel.

Adding and Erasing Channels in Memory

- When entering single-digit channels, press 0 first. For example, to select channel 8, press 0, then 8.

TV OPERATION

Programming the Channels, *continued*

- When entering three-digit channels, press the +100 button on the remote control first. For example, to select channel 104, press +100, then press 0, then 4.

You can manually add or erase a channel from your TV/VCR's memory.

- Press MENU to display the menu.
- Press CH▼ until "Setup" is selected.
- Press VOL+ to display the Setup menu.

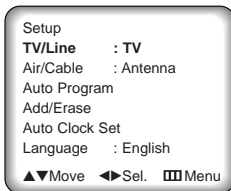

- Press CH▼ until "Add/Erase" is selected. Press VOL+.

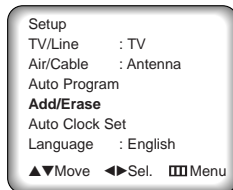

- Press VOL+ or VOL- to select a channel.
- Press CH▼ until "Add/Erase" is selected. Press VOL+ to select "Added" or "Erased".



You can still view a channel that is not stored in memory by using the number buttons to select the channel directly.

Setting the Clock

To record programs while you are away, or to use the sleep timer, you must first set the clock and calendar.

There are two ways to set the clock:

Option 1, Manual: The digits for hours and minutes are entered directly.

Option 2, Auto: The TV's clock is synchronized to a time signal sent out by the local PBS channel.

Option 1: Setting the clock directly ("Manual" Method)

- Press MENU to display the menu.
- Press CH▼ until "Time Set" is selected. Press VOL+.

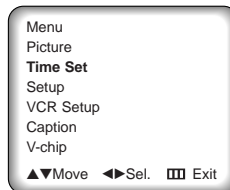

- Press VOL+. The Time Set menu appears.

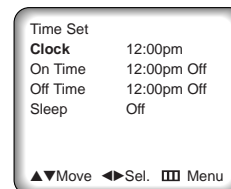

- Press VOL+ to select the hour digits. Press CH▼ or CH▲ repeatedly until the correct hour appears.



- Be sure to set the correct time of day (am or pm), which appears to the right of the minutes.

TV OPERATION

Setting the Clock, *continued*

- 5 Press VOL+ to select the minute digits. Press CH▲ or CH▼ repeatedly until the correct minute appears.

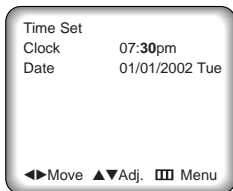

Press VOL+ to finish the clock set.

Setting the date

- 1 Press CH▼ to select the Date.

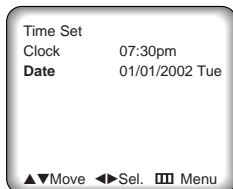

- 2 Press VOL+ to select the month digits. Press CH▲ or CH▼ to set the current month.

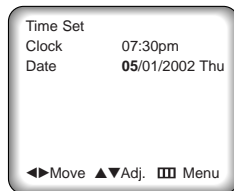

- 3 Press VOL+ to select the day digits. Press CH▲ or CH▼ to set the current day.

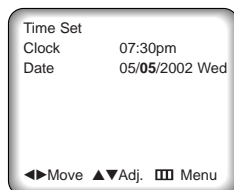

- 4 Press VOL+ to select the year digits. Press CH▲ or CH▼ to set the current year.



- ✓ If you make a mistake, press VOL- to move back to the incorrect item. Press CH▲ and CH▼ to change the item.

- 5 Press MENU to exit the menu.

Option 2: Using the Local PBS channel to Automatically Set the TV Clock:

If the TV clock is set using the Auto Clock Set option, it will be automatically synchronized to a time signal sent out by the local PBS channel.

- 1 Press MENU to display the menu.
- 2 Press CH▼ until "Setup" is selected. Press VOL+.

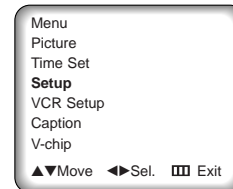

TV OPERATION

Setting the Clock, *continued*

- 3 Press CH▼ until "Auto Clock Set" is selected. Press VOL+.

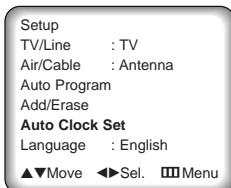

- 4 Press VOL+ to select Auto Clock Set "On".

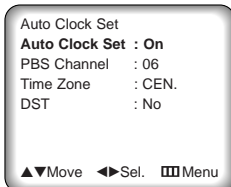

- 5 Press CH▼ to select the "PBS channel".

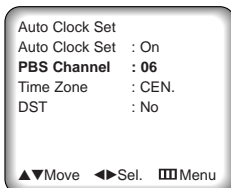

- 6 Press VOL +. Press CH▲ and CH▼ to select your local PBS channel. Press VOL + or VOL - again to lock in the PBS channel.

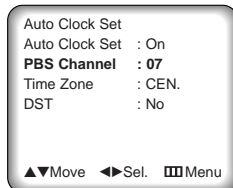

- ✓ The picture changes according to the channel.

- 7 Press the CH▼ button to select the "Time Zone"

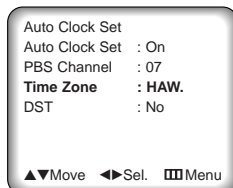

- ✓ While "Time Zone" is selected, press either VOL + or VOL - to change the Time Zone.

Sequence : ATL., EAST, CEN., MTN.,
PHOENIX, LAS, HAW.

- 8 Press CH▼ to select the "DST" (Daylight Savings Time).

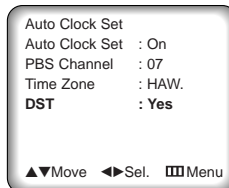

- ✓ While "DST" is selected, press VOL + to indicate "Yes," or "No."

(Set DST "Yes" on the appropriate day in April. And set DST "No" on the appropriate day in October.)

- 9 Press MENU to exit the menu.

- ✓ The time is automatically corrected when viewing your local PBS channel.

Choosing Picture Settings

Your TV/VCR has preset standard values for picture settings (contrast, brightness, sharpness, color, and tint). You can also customize these settings.

Customizing Picture Settings

- 1 Press MENU to display the menu.
- 2 Press CH▼ until "Picture" is selected. Press VOL+.

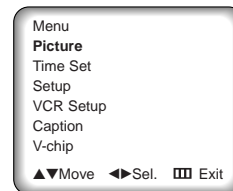

Choosing Picture Settings, *continued*

- 3 Press CH▲ or CH▼ to select Contrast, Brightness, Sharpness, Color, or Tint.

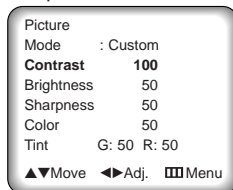

- 4 Press VOL+ or VOL- to change the setting.

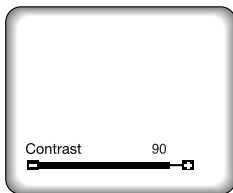

The setting for the feature appears on the screen.

- 5 Press MENU or wait a few seconds to store the setting.

✓ Once you've made changes to one or more of the picture features, your settings are stored in the TV/VCR's memory. Your custom picture setting now becomes the default setting for the TV/VCR.

- 6 Press CH▲ or CH▼ to select another setting or press MENU to exit the menu.

Using Automatic Picture Settings

This is a special feature that automatically adjusts your picture for you.

- 1 Press P-STD to select an automatic picture setting.

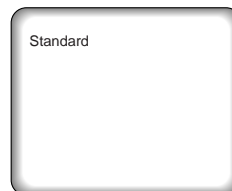

- Choose Standard to set the TV to operate at top performance according to your TV's specifications.
- Choose Mild when viewing the TV in low light, or when playing video games.
- Choose Custom if you want to adjust the settings yourself.

TV OPERATION

Setting the Sleep Timer

The sleep timer automatically turns off the TV/VCR at the time you select. This is convenient if you like to fall asleep with the television on.

- 1 Press MENU to display the menu.
- 2 Press CH▼ until "Time Set" is selected. Press VOL+.

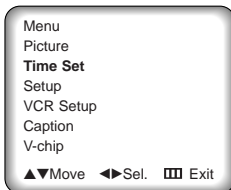

- 3 Press CH▼ until "Sleep" is selected.

- 4 Press VOL+ or VOL- to set the length of time you want the TV/VCR to remain on; off, 10, 20, 30, 60, 90, 120, 150, or 180 minutes.

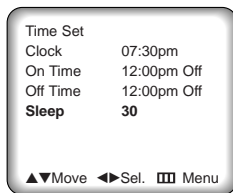

- 5 Press MENU to exit the menu.

Using the On/Off Timer

This timer turns the TV/VCR on or off at a specific time. You may set the on time, the off time, or both.

Whatever you choose, you must turn the timer on after you set the on or off times.

- 1 Press MENU to display the menu.
- 2 Press CH▼ until "Time Set" is selected. Press VOL+.

Setting the on time

- 1 Press CH▼ to select "On Time."
- 2 Press VOL+ to make the hour flash.

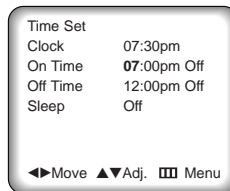

- 3 Press CH▲ or CH▼ to set the hour the set will turn on.
- 4 Press VOL+ to make the minutes flash.
- 5 Press CH▲ or CH▼ to set the minute the set will turn on.
- 6 Press VOL+ to make the Off flash.
- 7 Press CH▲ or CH▼ to set the timer to "ON."

Setting the off time

- 1 Press CH▼ to select "Off Time."
- 2 Press VOL+ to make the hour flash.
- 3 Press CH▲ or CH▼ to set the hour the set will turn off.
- 4 Press VOL+ to make the minutes flash.
- 5 Press CH▲ or CH▼ to set the minute the set will turn off.
- 6 Press VOL+ and CH▲ or CH▼ to set the timer "On".
- 7 Press MENU to exit the menu.

Inserting and Ejecting a Video Tape

To insert a video tape:

- 1 Hold the video tape window-side up, with the arrow pointing away from you.

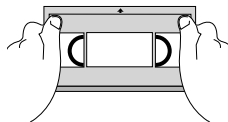

Don't try to insert a tape upside down or backwards.

Use only video tapes labeled "VHS." PAL and S-VHS video tapes are not compatible with this unit. Choose brand name, high quality tapes for best results.

- 2 Gently push the tape through the compartment door until you feel the VCR pull it in.

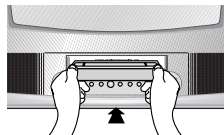

The TV/VCR loads the tape automatically.

If the power is off when you insert a tape, the TV/VCR turns on automatically.

If the safety tab of your video tape has been removed, the tape begins to play automatically.

- ✓ For more information on the safety tab, see page 40.

To eject a video cassette tape:

- 1 Press STOP to stop playing the tape.
 - ✓ When you're finished playing a video tape, rewind it and remove it from the TV/VCR to protect it from wear and tear.
- 2 Press STOP/EJECT on the TV/VCR to eject the tape.

Remove the tape and turn off the TV/VCR.

Playing a Video Tape

Playing a Tape

- 1 Insert the video tape.
- 2 If the tape doesn't begin to play automatically, press PLAY.



Then, if necessary, the TV/VCR will automatically adjust the tape's tracking.

- ✓ For information on automatic tracking, see page 25.
- ✓ For information on the time counter, see page 25.

Pausing

- 1 While a tape is playing, press P/STILL to pause the tape.

There may be vertical jitter or horizontal streaks on the screen while a tape is paused. You can try to eliminate these problems by pressing the TRK + and TRK - buttons on the remote control.

- ✓ For information on automatic tracking, see page 25.

After five minutes in pause, the TV/VCR automatically enters PLAY mode to protect the video heads.

- 2 Press PLAY to resume playing the tape.

Playing a Video Tape, *continued*

Using Picture Search

Picture Search lets you quickly search a pre-recorded video tape for a particular scene.

- 1 While playing a tape, press and release FF or REW.

The images from the tape are displayed on the screen at a high speed.

This technique is useful if you are searching a small amount of tape. If you want to search a large amount of tape, stop the tape before pressing FF or REW.

There is no sound while you search for a picture at high speeds, and some horizontal streaks may appear on the screen.

- 2 When you find the scene you want, press and release FF or REW again to resume playing the tape at regular speed.

Using Tracking

This feature automatically adjusts tracking on video tapes.

- 1 Insert and play a video tape.

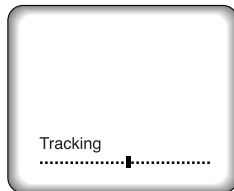

When the tape begins to play, the TV/VCR begins automatic tracking.

The tracking display will appear the first time a tape is played after being inserted into the TV/VCR, when there is a change in tape speed, or when you press TRK +, -.

- 2 If automatic tracking doesn't remove the streaks from the picture, press and hold TRK+ or TRK- until the streaks disappear.

Using the Time Counter

The time counter allows you to keep track of how much time (in hours, minutes, and seconds) has elapsed on the video tape.

The counter can also be useful if you want to find a specific point on a pre-recorded tape.

- 1 While a tape is playing, press DISPLAY twice.



The time counter appears.

The counter displays time only for recorded sections of tape. Blank tapes or blank sections of tapes do not affect the counter display.

- 2 Press CLEAR to set the counter to "00:00:00."

- ✓ The TV/VCR automatically resets the counter to "00:00:00" when you eject a tape or record.

- 3 Press DISPLAY to remove the time counter.

Using Memory Stop

Memory Stop makes it easy to find a particular scene in a video tape. The TV/VCR automatically stops rewinding or fast forwarding when the memory counter reaches "00:00:00." If you mark a desired scene as "00:00:00," you can search for it the next time you watch the tape.

- 1 While playing a tape, when you reach the scene you want, press DISPLAY twice.

The time counter appears.

- 2 Press CLEAR to reset the timer to "00:00:00."

VCR OPERATION

Playing a Video Tape, *continued*

To return to the scene you marked:

- 1 Press STOP.
- 2 Press FF or REW to return to the scene you marked.
The TV/VCR stops the tape when the counter reaches "00:00:00."
- 3 Press PLAY to view the scene you marked again.

Using P.PLUS

Press P.PLUS to compensate for a poor rental tape.



- 1 Insert a tape and press PLAY.
- 2 Press P.PLUS, and "Picture Plus Off" appears on the screen. Press P.PLUS again to turn to "Picture Plus On". The Rental Picture Plus functions only when a tape is being played.

- ✓ If the tape is ejected and reinserted, the Rental Plus feature will be OFF.

Recording TV Programs as You Watch

Recording

- 1 With your TV/VCR turned on, and with a tape in the unit, press SPEED.

- ✓ Be sure the record safety tab is in place. For information on the record safety tab, see page 40.



The tape speed appears in the lower left corner of the screen.

- 2 Press SPEED repeatedly until the speed you want (SLP, SP) appears.
 - ✓ SP (Standard Play) is the most common speed for recording. For more information on tape speeds, see page 40.

- 3 Select the television channel you want by pressing CH▲ or CH▼ or by using the number buttons.

If you are using the number buttons to select the channel, press 0 before a single-digit channel number (for channel 5, press 0, 5).

- 4 Press REC on the remote control.

The record indicator on the control panel illuminates and the TV/VCR begins recording.

- ✓ The TV/VCR automatically stops recording when it reaches the end of the tape.
- ✓ Press STOP at any time to stop recording.
- ✓ Don't change tape speeds while recording; this may cause picture distortion during playback.

When you finish recording, rewind the tape and remove it from the TV/VCR.

VCR OPERATION

Recording TV Programs as You Watch, *continued*

Editing While Recording

You can edit while recording, selecting only those scenes you want to record from the current television program.

This is especially helpful if you want to record a program without commercials.

- 1 Be sure you have begun recording and that the record indicator light on the front panel is lit.
- 2 Press P/STILL to temporarily stop recording.

After ten minutes in pause mode, the TV/VCR stops the tape automatically and switches to TV mode to protect the video heads. If this happens, press REC to resume recording.

- 3 To resume recording, press P/STILL again.

Using Advanced Recording Features

One-touch Recording

One-touch Recording (OTR) lets you record television programs with the touch of a button.

You can program the length of time (up to four hours) that you want to record.

- 1 Insert a video cassette tape, set the tape speed, and select the channel you want to record.

✓ The TV/VCR won't record if the record safety tab on the tape has been removed. For more information, see page 40.

- 2 Press REC on the remote control twice.

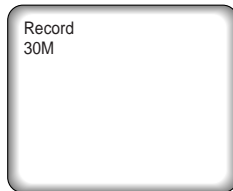

Your recording time options are: 30 minutes, 1 hour, 1 hour and 30 minutes, 2 hours, 2 hours and 30 minutes, 3 hours, or 4 hours.

- 3 Press REC on the remote control repeatedly until the time you want appears.

The TV/VCR begins recording.

You can increase the length of time you want to record at any time during the recording process by pressing the REC button again and choosing additional time.

If you want to stop recording before the time is up, press the REC button until the OTR display shows "Stop." The recording stops after a few seconds. You can also press STOP/EJECT on the front panel.

Timer Recording

You can set the timer to record up to six different programs. The timer can turn the TV/VCR on at the time you select, record for a selected length of time, and then turn off.

You can record a program one time, daily (every day, Monday through Friday), or weekly (the same day every week).

- 1 Press MENU to display the menu.
- 2 Press CH▼ until "VCR Setup" is selected. Press VOL+.

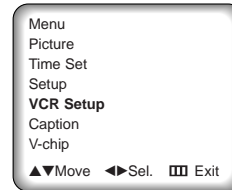

- ✓ The clock must be set to the correct time and date before you program the timer.

VCR OPERATION

Using Advanced Recording Features, *continued*

- 2 Press CH▼ until “Timer Record” is selected. Press VOL+.

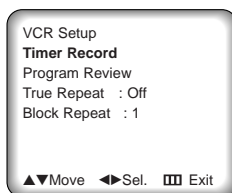

- 3 Press VOL+.
Press CH▲ or CH▼ to select the channel you want to record. Press VOL+ to lock in the channel you've chosen.



The TV/VCR assigns a number (1-6) to your entry which is used in the program review feature. (For more information, see page 22.)

- ✓ If you make a mistake at any point during programming, press VOL- and CH▲ until the number you want to change is flashing, then enter the correct number.

If you are recording a channel that comes through a cable converter box, enter the output number of the cable box.

- 4 Press CH▼ to select “Time.” Press VOL+.

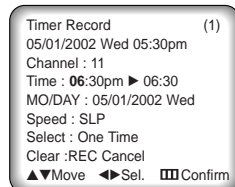

Press CH▲ or CH▼ to select the hour to begin recording.

- 5 Press VOL+.

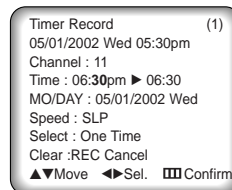

Press CH▲ or CH▼ to select the minute to begin recording.

- 6 Press VOL+.



Press CH▲ or CH▼ to select the hour to end recording.

- ✓ The TV/VCR automatically selects AM or PM for the ending time.

- 7 Press VOL+.



Press CH▲ or CH▼ to select the minute to end recording. Press VOL+ to lock in the minute.

VCR OPERATION

Using Advanced Recording Features, *continued*

- 8 Press CH▼ to select "MO/DAY." Press VOL+.

```
Timer Record (1)
05/01/2002 Wed 05:30pm
Channel : 11
Time : 06:30pm ▶ 07:30
MO/DAY : 05/01/2002 Wed
Speed : SLP
Select : One Time
Clear :REC Cancel
▲▼Move ◀▶Sel. ■■Confirm
```

Press CH▲ or CH▼ to select the month to begin recording.

- 9 Press VOL+.

```
Timer Record (1)
05/01/2002 Wed 05:30pm
Channel : 11
Time : 06:30pm ▶ 07:30
MO/DAY : 05/01/2002 Wed
Speed : SLP
Select : One Time
Clear :REC Cancel
▲▼Move ◀▶Sel. ■■Confirm
```

Press CH▲ or CH▼ to select the day to begin recording.

- 10 Press VOL+.

```
Timer Record (1)
05/01/2002 Wed 05:30pm
Channel : 11
Time : 06:30pm ▶ 07:30
MO/DAY : 05/01/2002 Wed
Speed : SLP
Select : One Time
Clear :REC Cancel
▲▼Move ◀▶Sel. ■■Confirm
```

Press CH▲ or CH▼ to select the year to begin recording. Press VOL+ to lock in the year.

- 11 Press CH▼ to select "Speed".

```
Timer Record (1)
05/01/2002 Wed 05:30pm
Channel : 11
Time : 06:30pm ▶ 07:30
MO/DAY : 05/01/2002 Wed
Speed : SLP
Select : One Time
Clear :REC Cancel
▲▼Move ◀▶Sel. ■■Confirm
```

Press VOL+ and CH▲ or CH▼ to select the speed at which you want to record.

- 12 Press CH▼ to select "Select". Press VOL+

```
Timer Record (1)
05/01/2002 Wed 05:30pm
Channel : 11
Time : 06:30pm ▶ 07:30
MO/DAY : 05/01/2002 Wed
Speed : SLP
Select : One Time
Clear :REC Cancel
▲▼Move ◀▶Sel. ■■Confirm
```

Press CH▼ to select the "One Time", or "Weekly", "Daily".

- 13 Press MENU to exit the menu.

- ✓ If you enter two program times that overlap, a program overlap warning appears on the TV screen, along with instructions for fixing the overlap.
- ✓ The REC indicator on the front panel of the TV/VCR is lit when program times are stored.

- 14 Press POWER to turn off the TV/VCR.

Important

- The TV/VCR should be off to record the programs you've chosen. But, if you are recording a channel that comes through a cable box, be sure to leave the cable box on and tuned to the channel you want to record.
- During timer recording, there is no picture on the screen because the power is off. If you want to watch the channel while it's being recorded, press POWER on the remote control.
- One-time timer programs clear from memory after recording. Daily and weekly programs remain in the timer until you remove them. If power to the TV/VCR is interrupted, all programs will be disabled until you reset the clock. Then, the programs will be restored.

VCR OPERATION

Using Advanced Recording Features, *continued*

Using Program Review

Program Review allows you to review all of the programmed recordings currently stored in the TV/VCR's memory and to remove a programmed recording quickly and easily.

- 1 Press MENU to display the menu.
- 2 Press CH▼ until "VCR Setup" is selected. Press VOL+.

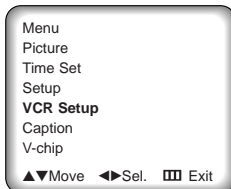

- 3 Press CH▼ until "Program Review" is selected. Press VOL+.

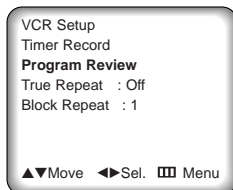

The information for the first program appears on the screen.

- ✓ Program Review is only available if you have programmed your TV/VCR to record at a later time.

- 4 To see the information for the program number, press VOL+.

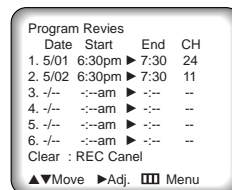

- ✓ If you're recording through a cable box, the Program Review screen displays the output channel of the cable box as the channel number to be recorded.
- 5 If you want to remove a program from memory, press CLEAR when the program you want to erase appears on the screen.

That program is erased from memory.

The TV/VCR is equipped with a program memory backup that saves all the timer program information if the power to the TV/VCR is interrupted.

If the unit has been without power, all of the timer program information will be disabled, until you reset the clock. When the clock is reset, the programs will be restored.

- 6 Press MENU to exit the menu.

Using True Repeat

You can set your TV/VCR to automatically repeat a tape or a section of tape. When you use True Repeat, your TV/VCR will play until it reaches the end of a tape. Then, it will rewind to the beginning of the tape and begin playing again.

- 1 Press MENU to display the menu.
- 2 Press CH▼ until "VCR Setup" is selected. Press VOL+.

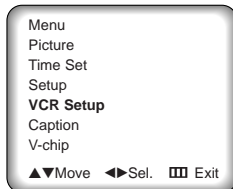

- 3 Press CH▼ until "True Repeat" is selected. Press VOL+ to turn True Repeat on.

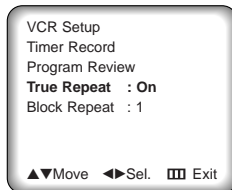

- 4 Press MENU to exit the menu.
- 5 Insert and play a pre-recorded video tape. The TV/VCR will play the tape until it reaches the end. Then, the TV/VCR will stop the tape, rewind it to the beginning, and begin playing again. If the TV/VCR reaches an unrecorded section of tape before it reaches the end, it will search forward and check the tape again. If it finds a recorded section of tape, it will begin playing. If the tape is still blank, it will continue to search forward, until it reaches the end of the tape.
- 6 Press STOP to end the repeat.

Using Block Repeat

Block Repeat allows you to repeat a section of tape that you select. You can repeat this section of tape (the "block") from one to ten times. "Repeat" section should be set up at a minimum ten-second interval.

- 1 Press MENU to display the menu.
- 2 Press CH▼ until "VCR Setup" is selected. Press VOL+.

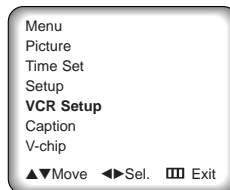

- 3 Press CH▼ until "Block Repeat" is selected. Press VOL+ to select the number of times you want your "block" to repeat.

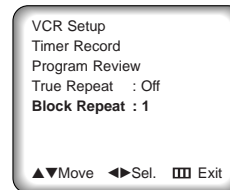

You can choose to have your "block" repeat from one to ten times.

- 4 Press MENU to exit the menu.
- 5 Insert and play a pre-recorded video tape.
- 6 Press REPEAT at the beginning of the "block" you want to repeat. ("Repeat setting" appears on the screen when the button is pressed.)

SPECIAL FEATURES

Using Block Repeat, *continued*

- When you reach the end of the "block," press REPEAT again.
The TV/VCR will rewind the tape to beginning of the block and repeat it.
The TV/VCR will repeat the block as many times as the number you set in step 3.
- To stop block repeat, press the STOP, P/STILL, or PLAY buttons. You can also cancel block repeat by fast forwarding or rewinding to a point outside of the "block."

Viewing Closed Captions

Your TV/VCR decodes and displays closed captions. These captions are usually subtitles for the hearing impaired or translations into another language. All VCRs record the closed caption signal from television programs, so home-recorded video tapes also provide closed captions.

- Most pre-recorded commercial video tapes provide closed captions. Check for this symbol  in your television schedule and on tape packaging.
- Press MENU to display the menu.
 - Press CH▼ until "Caption" is selected. Press VOL+.

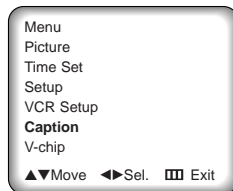

- Press VOL+ to turn the closed caption feature on.

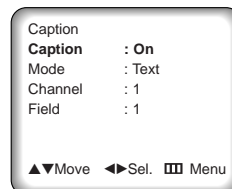

- Misspellings and unusual characters sometimes appear in closed caption transmissions.
 - There may be a small delay before captions appear when you change channels.
- Press or CH▼ to select, "Mode." Press VOL+ to choose "Caption" or "Text."

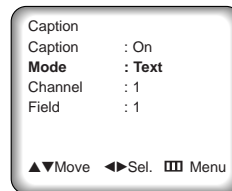

- In text mode, information unrelated to the captions is displayed, such as news or weather. Text often covers a large portion of the screen.

- If you wish, use CH▲, CH▼, or VOL+ to change the channel or field. Then, press MENU to return to normal viewing.

- Different channels display different information. For example, Channel 1 may have subtitles in English, while Channel 2 has subtitles in Spanish.

The second field contains additional information that could not be included in the first field.

Using the V-Chip

The V-Chip feature automatically locks out programming that is deemed inappropriate for children. The user must first enter a PIN (personal ID number) before any of the V-Chip restrictions can be set up or changed.

Setting Up Your Personal ID Number (PIN)

- 1 Press MENU to display the menu.
- 2 Press CH▼ until "V-chip" is selected. Press VOL+.

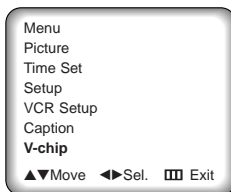

- 3 Press VOL+. The "Enter PIN" screen will appear. Enter your 4-digit PIN number.

Note: The default PIN number for a new TV set is "0-0-0-0."

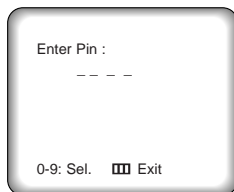

- 4 After entering a valid PIN number, the "V-chip" screen will appear. Press CH▼ and select "Change Pin."

- 5 While the "Change Pin" is selected, press VOL +. The Change Pin screen will appear. Choose any 4-digits for your PIN and enter them.

As soon as the 4 digits are entered, the "Confirm new Pin" screen appears. Re-enter the same 4 digits. When the Confirm screen disappears, your PIN has been memorized.

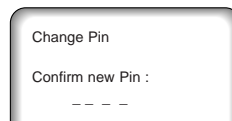
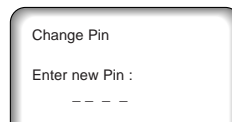

Note: If you forget the PIN, press the remote-control keys in the following sequence. (this resets the pin to 0-0-0-0:)

POWER OFF → MUTE → 8 → 2 → 4 → POWER ON.

How to Enable/Disable the V-Chip

- 1 Press MENU to display the menu.
- 2 Press CH▼ until "V-chip" is selected. Press VOL+.
- 3 Press VOL +. The "Enter PIN" screen will appear. Enter your 4-digit PIN number.
- 4 The "V-Chip" screen will appear, and "V-Chip lock" will be selected. To enable the V-Chip feature, press VOL + so that the "V-Chip lock" field is Yes. (Pressing VOL + will alternate between Yes and No.)

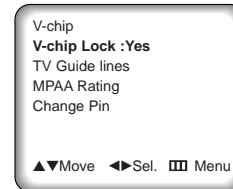

Using the V-Chip, *continued*

How to Set up Restrictions Using the "TV guidelines"

First, set up a personal identification number (PIN), and enable the V-Chip. (See last sections.) Parental restrictions can be set up using either of two methods: The TV guidelines or the MPAA rating.

- 1 Press MENU to display the menu.
- 2 Press CH▼ until "V-chip" is selected. Press VOL+.
- 3 Press VOL+. The "Enter PIN" screen will appear. Enter your 4-digit PIN number.
- 4 The "V-chip mode" screen will appear. Press CH▼ to select the "TV guide lines."

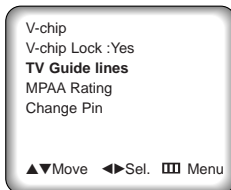

- 5 Press VOL+. The "TV guidelines" screen will appear. Press the CH▲, CH▼ buttons to select one of the six age-based categories:

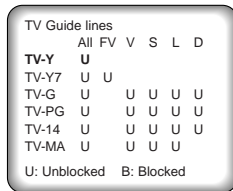

TV-Y Young children
TV-Y7 Children 7 and over

TV-G General audience
TV-PG Parental guidance
TV-14 Viewers 14 and over
TV-MA Mature audience

Note: These categories consist of two separate groups. TV-Y and TV-Y7 (young children through age 7), and TV-G through TV-MA (everybody else).

The restrictions for these two groups work independently:

If a household includes very young children as well as young adults, the TV guidelines must be set up separately for each age group. (See next step.)

- 6 At this point, one of the TV-Ratings is selected (red color).

Press VOL+: Depending on your existing setup, either "U" or "B" will be selected.

(U= Unblocked, B= Blocked)

While the "U" or "B" is red color, press CH▲ or CH▼ to block or unblock the category.

Press MENU once to save the TV guidelines. A TV-Rating will be selected, and no letters will be selected. To exit this screen, press MENU again. To select a different TV-Rating, press CH▲ or CH▼ and then repeat the process.

Note 1: The TV-Y7, TV-PG, TV-14 and TV-MA have additional options. See the next step to change any of the following sub-ratings:

FV: Fantasy violence
D: Dialog
L: Adult language
S: Sexual situation
V: Violence

Note 2: The V-Chip will automatically block certain categories that are "more restrictive".

For example, if you block "TV-Y" category, then TV-Y7 will automatically be blocked.

Similarly, if you block the TV-G category, then all the categories in the "young adult" group will be blocked (TV-G, TV-PG, TV-14 and TV-MA). The sub-ratings (D, L, S, V) work together similarly. (See next section).

Using the V-Chip, *continued*

- 7 How to set the FV, D, L, S and V sub-ratings.

First, select one of these TV-Ratings: TV-Y7, TV-PG, TV-14 or TV-MA (See Step 4, above).

Next, while the TV-Rating is selected, repeatedly press VOL+. This will cycle through the available sub-ratings (FV, L, S, D or V). A selecting letter ("U" or "B") will be displayed for each sub-rating. While the "U" or "B" is selecting, press CH▲ or CH▼ to change the sub-rating.

Press MENU once to save the TV guidelines.

A particular TV-Rating will be selected, and no letters will be selected. To exit this screen, press MENU again. To select a different TV-Rating, press CH▲ or CH▼ and then repeat the process.

Note: The V-chip will automatically block certain categories that are "More restrictive".

For example, if you block the "L" sub-rating in TV-PG, then the "L" sub-ratings in TV-14 and TV-MA will automatically blocked.

- 8 Press MENU to clear all the screens.
(Or proceed to the next section, and set up additional restrictions based on the MPAA codes).

How to Set up Restrictions using the MPAA Ratings: G, PG, PG-13, R, NC-17, X

The MPAA rating system uses the Motion Picture Association of America (MPAA) system, and its main application is for movies. (Eventually, movie videocassettes will be encoded with MPAA ratings.) When the V-Chip lock is on, the TV will automatically block any programs that are coded with objectionable ratings (either MPAA or TV-Ratings).

- 1 Press MENU to display the menu.
- 2 Press CH▼ until "V-chip" is selected. Press VOL+.
- 3 Press VOL+. The "Enter PIN" screen will appear. Enter your 4-digit PIN number.
- 4 The "V-chip" screen will appear. Press CH▼ to select the "MPAA rating".

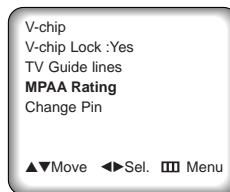

- 5 While "MPAA rating" is selected, press the VOL+ button. The "MPAA rating" screen will appear.

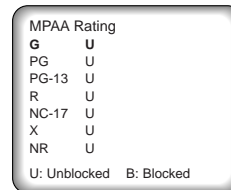

- 6 Repeatedly press CH▼ to select a particular MPAA category. Pressing CH▼ will cycle through the MPAA categories:

G: General audience (no restrictions).
 PG: Parental guidance suggested.
 PG-13: PG-13(Parents strongly cautioned).
 R: R(Restricted. Children under 17 should be accompanied by an adult).
 NC-17: No children under age 17.
 X: X (Adults only).
 NR: Not rated.

Using the V-Chip, *continued*

Next, press VOL + to activate the category. While a particular category is selected, press VOL + to activate it.

Press MENU to exit the V-Chip menu.

Note: The V-Chip will automatically block any category that is “more restrictive”.

For example, if you block the “PG-13” category, then “R”, “NC-17” and “X” will automatically be blocked also.

How to Reset the TV after the V-Chip Blocks a Channel (“Emergency Escape”)

If the TV is tuned to a restricted channel, the V-Chip will block it. The screen will go blank and the following message will appear: “Excessive rating.”

To resume normal viewing, tune to a different channel using the number buttons. Under certain conditions (depending on the rating of the local TV programs) the V-Chip might lock out all the channels.

In this case, use the V-Chip function for an “emergency escape”:

- 1 Press MENU to display the menu.
- 2 Press CH▼ until “V-chip” is selected. Press VOL+.
- 3 Press VOL+. The “Enter PIN” screen will appear. Enter your 4-digit PIN number.

- 4 Press VOL+: The V-Chip lock field will appear, and “V-Chip lock” will be selected. Press VOL+ to switch V-Chip off. (Repeatedly pressing VOL+ will alternate between yes and no.)

Using Special Playback Features

Your TV/VCR provides you with special features that are available when you are playing a tape. These features are Frame Advance, Skip Search, and Slow Motion.

Frame Advance

Frame Advance allows you to watch a tape frame-by-frame.

- 1 While a tape is playing, press P/STILL on the remote.

If the picture jitters, press TRK +, - .

- 2 Press F.ADV/SKIP repeatedly to move forward frame-by-frame. Do not hold the button down.
Press PLAY to resume normal playback.

Skip search

Skip search allows you to quickly search through a short section of tape.

- 1 While a tape is playing, press F.ADV/SKIP.

The TV/VCR will fast-forward through the tape for 60 seconds, then continue playing.

Slow motion

You can watch a tape at various slow-motion speeds.

- 1 While a tape is playing, press SLOW + or SLOW - on the remote.

If the picture is jittery or shows noise, try using the TRK buttons to clear the picture.

- 2 Press SLOW + or SLOW - to adjust the slow motion speed between 1/5 and 1/60 normal speed.

- 3 Press PLAY to resume normal play.

There is no sound during slow motion.

- ✓ It is normal to occasionally see some streaks or jitter during slow motion play.
- ✓ If slow motion continues for more than five minutes, the TV/VCR may play automatically to protect the tape and video heads.

Jet search

When pressing FF or REW during play, the search speed becomes faster.

SPECIAL FEATURES

Copying, or Dubbing, a Video

To make a copy, or “dub,” of another video tape, you need:

- your TV/VCR
- a separate VCR (or camcorder)
- two A/V cables with connectors. (You can find these at most electronics supply stores.)

Important warning:

One Federal Court has held that unauthorized recording of copyrighted TV programs may be an infringement of copyright laws.

Making the Connections

Attach one end of the video/audio cable to the VIDEO/AUDIO OUT connector of the playback VCR (or camcorder) and the other end to the VIDEO/AUDIO IN connector of the TV/VCR.

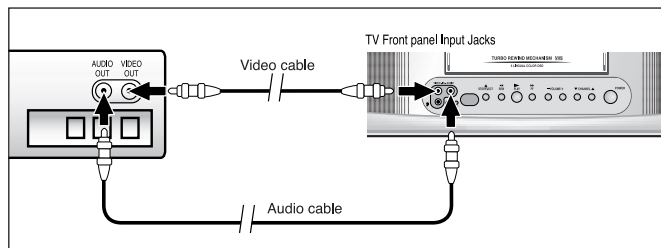

Dubbing

- 1 Insert the video cassette tape you want to copy into the playback VCR (or camcorder).
- 2 Insert a blank video tape (or any video tape with the record safety tab intact) into the recording TV/VCR.
- 3 Press LINE IN on the remote control of the recording TV/VCR.

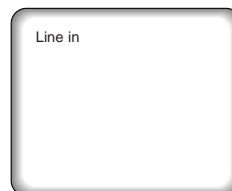

The words “Line in” appear in the upper left corner of the TV/VCR screen.

- ✓ The TV/VCR will be recording from the incoming line rather than from the normal broadcast signal.

“Line in” will remain on-screen until the PLAY button is pressed on the playback VCR.

- 4 To begin recording, simultaneously press REC on the recording TV/VCR's remote control and PLAY on the playback VCR (or camcorder).
- 5 When you are finished, press STOP on both the VCR (or camcorder) and the TV/VCR to stop recording.
- 6 Press LINE IN to return to normal TV viewing.

Identifying TV Problems

Poor picture, no picture, blurred picture, or blue screen.

- Try another channel. Make sure the unit is plugged into a working wall outlet.
- Adjust the antenna.
- Press LINE IN.
- Check all wire connections.

Poor sound quality.

- Try another channel.
- Adjust the antenna.

No color, wrong colors or tints.

- Make sure the program is broadcast in color.
- Adjust the picture settings.
- If the set is moved or turned in a different direction, the power should be OFF for at least 30 minutes.

Picture rolls vertically.

- Adjust the antenna.
- Check all wire connections.

Identifying VCR Problems

Unit won't turn on.

- Make sure the unit is plugged into a working wall outlet.
- Press the POWER button.

Unit won't take video tape.

- Make sure the tape is window side up with the arrow pointing away from you.
- Make sure there is no other tape in the compartment.

Unit didn't record a program.

- Make sure the antenna or cable is connected and that the TV/VCR is receiving the broadcast signal.
- Make sure the record safety tab on the tape is intact.

Unit didn't record a timer program.

- Make sure the unit was turned off.
- Check the programmed start and stop times.
- Make sure the time is set correctly.

There is no picture, the picture is distorted during video tape playback, or noise or streaks appear in the picture.

- Adjust the tracking.
- Clean the video heads.
- Make sure there has been a recording on the tape.

You can't receive regular broadcasts.

- Check the antenna or cable connections.

Rewind command doesn't work.

- Make sure the VCR is not in pause mode.
- Make sure the tape hasn't already been rewound.

Fast forward command doesn't work.

- Make sure the VCR is not in pause mode.
- Make sure the tape hasn't already been forwarded.

Picture is streaked during pause mode.

This is normal for SP recordings.

Caring for Your TV/VCR

Please follow these guidelines to get the maximum performance from your TV/VCR.

Placement

- Do not place the TV/VCR near extremely hot, cold, humid or dusty places.
- Do not place the TV/VCR near appliances with electric motors that create magnetic fields, such as vacuum cleaners.
- Keep the ventilation openings clear; do not place the TV/VCR on a soft surface, such as cloth or paper.
- Place the TV/VCR in an upright position only.

Liquids

Do not handle liquids near or on the TV/VCR. Liquids that spill into it can cause serious damage.

Cabinet

- Never open the cabinet or touch the parts inside.
- Wipe your TV/VCR with a clean, dry cloth. Never use water, cleaning fluids, wax, or chemicals.
- Do not put heavy objects on top of the cabinet.

Video Heads

- Use a head cleaning tape to remove any dirt that has accumulated on the video heads.
- Follow the instructions that come with the cleaning tape; excessive use of a cleaning tape can shorten head life.

Temperature

If your TV/VCR is moved from a cold to a warm place, unplug the power cord, and allow at least two hours for moisture that may have formed inside the unit to dry completely.

About Video Tapes

Use only video tapes marked VHS with this TV/VCR.

Caring for Video Tapes

- Keep tapes away from direct sunlight, heat or cold.
- Insert tapes with the window side up and the arrow pointing away from you.
- Do not subject tapes to violent vibrations or shocks.
- Never try to take apart or splice a video tape.
- Do not open the cassette, touch the tape, or put anything inside the tape case.
- Read the instructions supplied with video tapes.

Recording Speeds

You can play or record a tape at:

- SP (Standard Play) speed
- SLP (Super Long Play) speed

Your TV/VCR automatically plays tapes at the proper speed.

Recording at slower tape speeds allows tapes to hold more program material.

TAPE	SP	SLP
T-60	1 hr.	3 hrs.
T-120	2 hrs.	6 hrs.
T-160	2 hrs., 40 mins.	8 hrs.

The Record Safety Tab

Most video tapes have a safety tab that must be intact to record. To protect a tape from erasure, you can break off the tab.

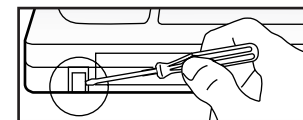

To record on a cassette with the tab removed, cover the hole with cellophane tape.

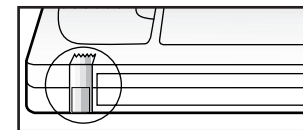

Specifications

Format

VHS Standard

Recording system

Rotary, azimuth four-head
helical scanning system

Luminance: FM azimuth
recording

Color signal: Converted
subcarrier phase shift recording

Television system

NTSC-type color signal EIA
Standard (525 lines, 60 fields)

Audio track

One track

Tape width

12.7 mm (1/2 inch)

Record speed

SP: 33.35 mm/s (1.31 in./s)

SLP: 11.12 mm/s (0.43 in./s)

Record/playback time

480 minutes with T-160 used in
SLP mode

FF/REW time

Less than 2 min. with T-120

Heads

Video: Four rotary heads

Audio/control: One stationary
head

Erase: One full track erase, one
audio track erase

Video

Input

VIDEO IN jack (RCA) 1.0 V p-p,
75-ohm unbalanced

Audio

Input

AUDIO IN jack (RCA) -8 dBm,
50K-ohm unbalanced

TV tuners

VHF input: ch. 2 – ch. 13, cable
channels *4A, A-W, W+1-W+84,

A-5-A-1" 75-ohm unbalanced

UHF input: ch. 14 – ch. 69 VHF,
UHF one input 75-ohm unbalanced

Operating temperature

41° F – 104° F (5° C – 40° C)

Operating humidity

10% – 75%

*Equipment specifications are
subject to change without
notice*

Model	CMC13410	CMC19410
Power requirements	120V AC, 60Hz	120V AC, 60Hz
Power consumption	Approx. 60watts when on Approx. 5watts when off	Approx. 70watts when on Approx. 5watts when off
Dimensions(w x d x h)	366 x 382 x 381 mm 14.41 x 15.04 x 15.00 inches	486 x 468 x 487 mm 19.13x 18.43 x 19.17 inches
Weight	11.2kg ; 24.69lbs	19kg ; 41.89lbs

Curtis Mathes Color Television

LIMITED WARRANTY TO ORIGINAL PURCHASER

This Curtis Mathes brand product, as supplied and distributed by Curtis Mathes and delivered new, in the original carton to the original consumer purchaser, is warranted by Curtis Mathes against manufacturing defects in materials and workmanship for a limited warranty period of:

**Ninety (90) Days Labor and One (1) Year Parts and
Two (2) Years Warranty for Picture Tube (CRT)**

This limited warranty begins on the original date of purchase, and is valid only on products purchased and used in the United States. To receive warranty service, the purchaser must contact Curtis Mathes for determination of problem and service procedures. Warranty service can only be performed by a Curtis Mathes authorized service center. The original dated bill of sale must be presented upon request as proof of purchase to Curtis Mathes or authorized service center.

Curtis Mathes will repair or replace this product, at our option and at no charge as stipulated herein, with new or reconditioned parts or products if found to be defective during the limited warranty period specified above. All replaced parts and products become the property of Curtis Mathes and must be returned to Curtis Mathes. Replacement parts and products assume the remaining original warranty, or ninety (90) days, whichever is longer.

To obtain warranty service, please contact Curtis Mathes at: **1-877-456-2788**

For more product and customer support information, visit the Curtis Mathes website at:

www.curtismathes.com

In-home service will be provided during the warranty labor period subject to availability within the contiguous United States. In-home service is not available in all areas. To receive in-home service, the product must be unobstructed and accessible to service personnel. If during in-home service repair can not be completed, it may be necessary to remove, repair and return the product. If in-home service is unavailable, Curtis Mathes may elect, at our option to provide for transportation of our choice to and from a Curtis Mathes authorized service center. Otherwise, transportation to and from the Curtis Mathes authorized service center is the responsibility of the purchaser.

This limited warranty covers manufacturing defects in materials and workmanship encountered in normal, noncommercial use of this product and shall not apply to the following, including, but not limited to: damage which occurs in shipment; delivery and installation; applications and uses for which this product was not intended; altered product or serial numbers; cosmetic damage or exterior finish; accidents, abuse, neglect, fire, water, lightning or other acts of nature; use of products, equipment, systems, utilities, services, parts, supplies, accessories, applications, installations, repairs, external wiring or connectors not supplied or authorized by Curtis Mathes which damage this product or result in service problems; incorrect electrical line voltage, fluctuations and surges; customer adjustments and failure to follow operating instructions, cleaning, maintenance and environmental instructions that are covered and prescribed in the instruction book; product removal and reinstallation; reception problems and distortion related to noise, echo, interference or other signal transmission and delivery problems; picture tube (CRT) brightness related to normal aging, or burned-in images. Curtis Mathes does not warrant uninterrupted or error-free operation of the product.

.....

THERE ARE NO EXPRESSED WARRANTIES OTHER THAN THOSE LISTED AND DESCRIBED ABOVE, AND NO WARRANTIES WHETHER EXPRESSED OR IMPLIED, INCLUDING, BUT NOT LIMITED TO, ANY IMPLIED WARRANTIES OF MERCHANTABILITY OR FITNESS FOR A PARTICULAR PURPOSE, SHALL APPLY AFTER THE EXPRESSED WARRANTY PERIODS STATED ABOVE, AND NO OTHER EXPRESSED WARRANTY OR GUARANTY GIVEN BY ANY PERSON, FIRM OR CORPORATION WITH RESPECT TO THIS PRODUCT SHALL BE BINDING ON Curtis Mathes. Curtis Mathes SHALL NOT BE LIABLE FOR LOSS OF REVENUE OR PROFITS, FAILURE TO REALIZE SAVINGS OR OTHER BENEFITS, OR ANY OTHER SPECIAL, INCIDENTAL OR CONSEQUENTIAL DAMAGES CAUSED BY THE USE, MISUSE OR INABILITY TO USE THIS PRODUCT, REGARDLESS OF THE LEGAL THEORY ON WHICH THE CLAIM IS BASED, EVEN IF Curtis Mathes HAS BEEN ADVISED OF THE POSSIBILITY OF SUCH DAMAGES. NOR SHALL RECOVERY OF ANY KIND AGAINST Curtis Mathes BE GREATER IN AMOUNT THAN THE PURCHASE PRICE OF THE PRODUCT SOLD BY Curtis Mathes AND CAUSING THE ALLEGED DAMAGE. WITHOUT LIMITING THE FOREGOING, PURCHASER ASSUMES ALL RISK AND LIABILITY FOR LOSS, DAMAGE OR INJURY TO PURCHASER AND PURCHASER'S PROPERTY AND TO OTHERS AND THEIR PROPERTY, ARISING OUT OF THE USE, MISUSE OR INABILITY TO USE THIS PRODUCT SOLD BY Curtis Mathes, NOT CAUSED DIRECTLY BY THE NEGLIGENCE OF Curtis Mathes. THIS LIMITED WARRANTY SHALL NOT EXTEND TO ANYONE OTHER THAN THE ORIGINAL PURCHASER OF THIS PRODUCT, IS NONTRANSFERABLE AND STATES YOUR EXCLUSIVE REMEDY.

Some states do not allow limitations on how long an implied warranty lasts, or the exclusion or limitation of incidental or consequential damages, so the above limitations or exclusions may not apply to you. This warranty gives you specific legal rights, and you may also have other rights which vary from state to state.

MEMO

This product is listed by Underwriter's Laboratories, Inc. It is designed and manufactured to meet rigid U.L. safety standards against X-radiation, fire casualty and electrical hazards.

**As an ENERGY STAR® Partner,
Curtis Mathes has determined that
this product or product model meets the
ENERGY STAR® guidelines for energy efficiency.**

CurtisMathes

**3250 W. Big Beaver Rd.
Troy, MI 48084**

**For more information about this or other Curtis Mathes
products, please visit our web site at: www.curtismathes.com.**